

IRG4P254SPbF

Standard Speed IGBT

INSULATED GATE BIPOLAR TRANSISTOR

Features

- Standard: Optimized for minimum saturation voltage and operating frequencies up to 10kHz
- Generation 4 IGBT design provides tighter parameter distribution and higher efficiency than Generation 3
- Industry standard TO-247AC package

Benefits

- Generation 4 IGBT's offer highest efficiency available
- IGBT's optimized for specified application conditions
- High Power density
- Lower conduction losses than similarly rated MOSFET
- Lower Gate Charge than equivalent MOSFET
- Simple Gate Drive characteristics compared to Thyristors

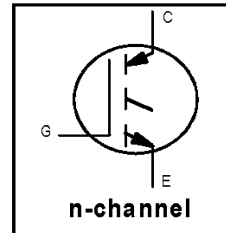

$V_{CES} = 250V$
$V_{CE(on) typ.} = 1.32V$
@ $V_{GE} = 15V, I_C = 55A$

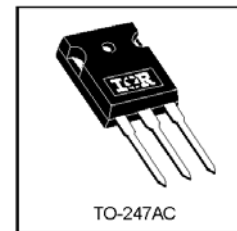

Absolute Maximum Ratings

	Parameter	Max.	Units
V_{CES}	Collector-to-Emitter Breakdown Voltage	250	V
$I_C @ T_C = 25^\circ C$	Continuous Collector Current	98*	A
$I_C @ T_C = 100^\circ C$	Continuous Collector Current	55	
I_{CM}	Pulsed Collector Current ①	196	
I_{LM}	Clamped Inductive Load Current ②	196	
V_{GE}	Gate-to-Emitter Voltage	± 20	V
E_{ARV}	Reverse Voltage Avalanche Energy ③	160	mJ
$P_D @ T_C = 25^\circ C$	Maximum Power Dissipation	200	W
$P_D @ T_C = 100^\circ C$	Maximum Power Dissipation	78	
T_J	Operating Junction and	-55 to + 150	$^\circ C$
T_{STG}	Storage Temperature Range		
	Soldering Temperature, for 10 seconds		
	Mounting torque, 6-32 or M3 screw.	10 lbf•in (1.1N•m)	

Thermal Resistance

	Parameter	Typ.	Max.	Units
$R_{\theta JC}$	Junction-to-Case	—	0.64	$^\circ C/W$
$R_{\theta CS}$	Case-to-Sink, Flat, Greased Surface	0.24	—	
$R_{\theta JA}$	Junction-to-Ambient, typical socket mount	—	40	
Wt	Weight	6.0 (0.21)	—	g (oz)

* Package limited to 70A

IRG4P254SPbF

International
IR Rectifier

Electrical Characteristics @ T_J = 25°C (unless otherwise specified)

	Parameter	Min.	Typ.	Max.	Units	Conditions
V _{(BR)CES}	Collector-to-Emitter Breakdown Voltage	250	—	—	V	V _{GE} = 0V, I _C = 250μA
V _{(BR)ECS}	Emitter-to-Collector Breakdown Voltage ④	18	—	—	V	V _{GE} = 0V, I _C = 1.0A
ΔV _{(BR)CES} /ΔT _J	Temperature Coeff. of Breakdown Voltage	—	0.33	—	V/°C	V _{GE} = 0V, I _C = 1.0mA
V _{CE(ON)}	Collector-to-Emitter Saturation Voltage	—	1.32	1.5	V	I _C = 55A I _C = 98A I _C = 55A, T _J = 150°C V _{GE} = 15V See Fig.2, 5
		—	1.69	—		
		—	1.31	—		
V _{GE(th)}	Gate Threshold Voltage	3.0	—	6.0		V _{CE} = V _{GE} , I _C = 250μA
ΔV _{GE(th)} /ΔT _J	Temperature Coeff. of Threshold Voltage	—	-12	—	mV/°C	V _{CE} = V _{GE} , I _C = 250μA
g _{fe}	Forward Transconductance ⑤	43	63	—	S	V _{CE} = 100V, I _C = 55A
I _{CES}	Zero Gate Voltage Collector Current	—	—	250	μA	V _{GE} = 0V, V _{CE} = 250V
		—	—	2.0		V _{GE} = 0V, V _{CE} = 10V, T _J = 25°C
		—	—	1000		V _{GE} = 0V, V _{CE} = 250V, T _J = 150°C
I _{GES}	Gate-to-Emitter Leakage Current	—	—	±100	nA	V _{GE} = ±20V

Switching Characteristics @ T_J = 25°C (unless otherwise specified)

	Parameter	Min.	Typ.	Max.	Units	Conditions
Q _g	Total Gate Charge (turn-on)	—	200	300	nC	I _C = 55A V _{CC} = 200V V _{GE} = 15V See Fig. 8
Q _{ge}	Gate - Emitter Charge (turn-on)	—	29	44		
Q _{gc}	Gate - Collector Charge (turn-on)	—	66	99		
t _{d(on)}	Turn-On Delay Time	—	40	—	ns	T _J = 25°C I _C = 55A, V _{CC} = 200V V _{GE} = 15V, R _G = 5.0Ω Energy losses include "tail" See Fig. 9, 10, 14
t _r	Rise Time	—	44	—		
t _{d(off)}	Turn-Off Delay Time	—	270	400		
t _f	Fall Time	—	510	760		
E _{on}	Turn-On Switching Loss	—	0.38	—	mJ	See Fig. 11, 14
E _{off}	Turn-Off Switching Loss	—	3.50	—		
E _s	Total Switching Loss	—	3.88	5.3		
t _{d(on)}	Turn-On Delay Time	—	38	—	ns	T _J = 150°C, I _C = 55A, V _{CC} = 200V V _{GE} = 15V, R _G = 5.0Ω Energy losses include "tail" See Fig. 11, 14
t _r	Rise Time	—	45	—		
t _{d(off)}	Turn-Off Delay Time	—	400	—		
t _f	Fall Time	—	940	—		
E _s	Total Switching Loss	—	6.52	—	mJ	
L _E	Internal Emitter Inductance	—	13	—	nH	Measured 5mm from package
C _{ies}	Input Capacitance	—	4500	—	pF	V _{GE} = 0V V _{CC} = 30V f = 1.0MHz See Fig. 7
C _{oes}	Output Capacitance	—	510	—		
C _{res}	Reverse Transfer Capacitance	—	100	—		

Notes:

- ① Repetitive rating; V_{GE} = 20V, pulse width limited by max. junction temperature. (See fig. 13b)
- ② V_{CC} = 80%(V_{CES}), V_{GE} = 20V, L = 10μH, R_G = 5.0Ω. (See fig. 13a)
- ③ Repetitive rating; pulse width limited by maximum junction temperature.
- ④ Pulse width ≤ 80μs; duty factor ≤ 0.1%.
- ⑤ Pulse width 5.0μs, single shot.

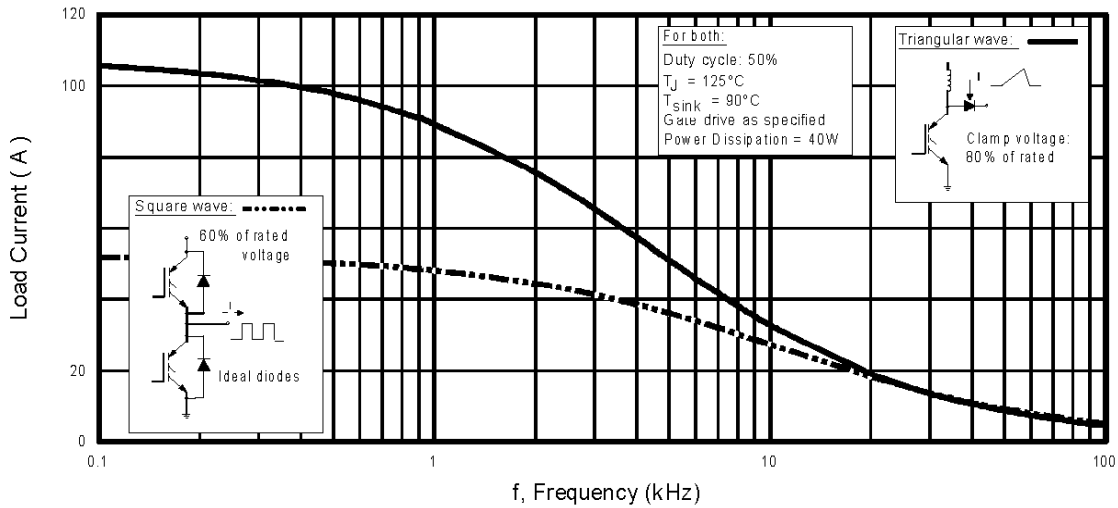

Fig. 1 - Typical Load Current vs. Frequency
 (Load Current = I_{RMS} of fundamental)

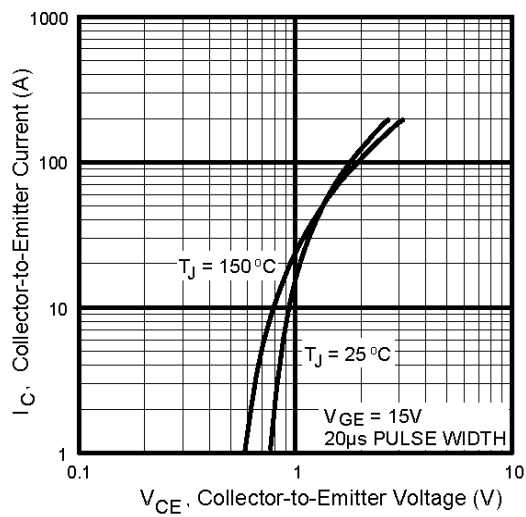

Fig. 2 - Typical Output Characteristics

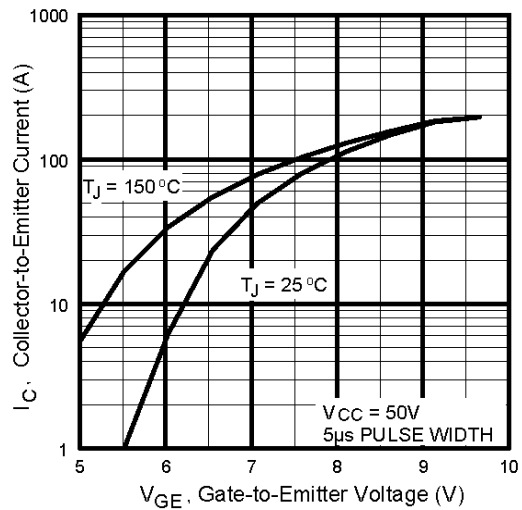

Fig. 3 - Typical Transfer Characteristics

IRG4P254SPbF

International
IR Rectifier

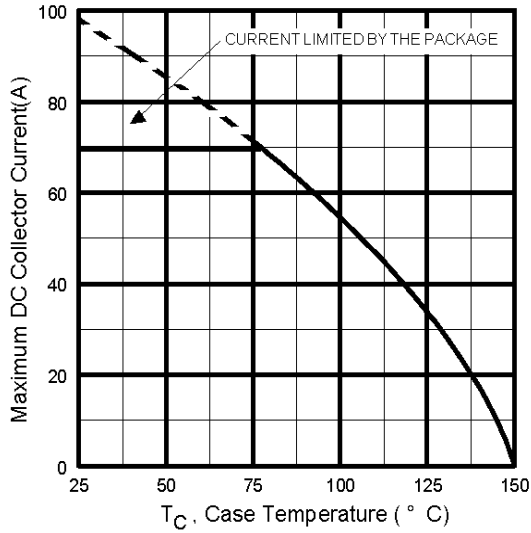

Fig. 4 - Maximum Collector Current vs. Case Temperature

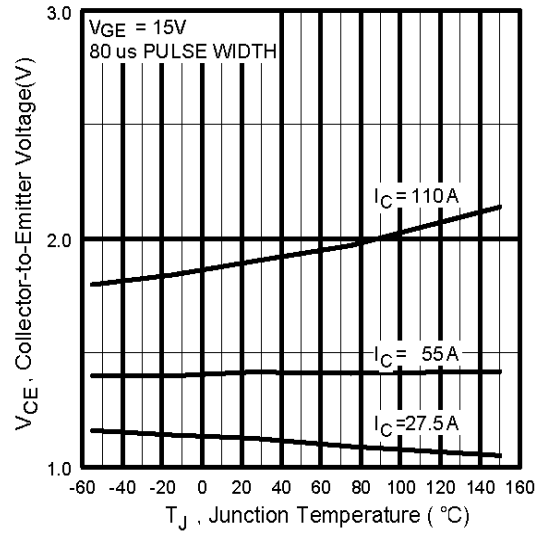

Fig. 5 - Typical Collector-to-Emitter Voltage vs. Junction Temperature

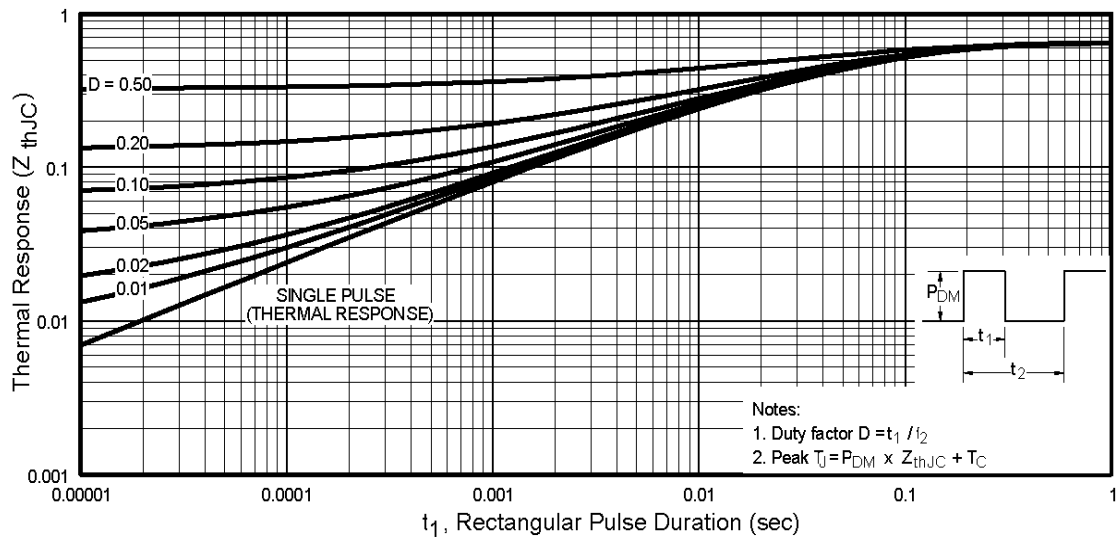

Fig. 6 - Maximum Effective Transient Thermal Impedance, Junction-to-Case

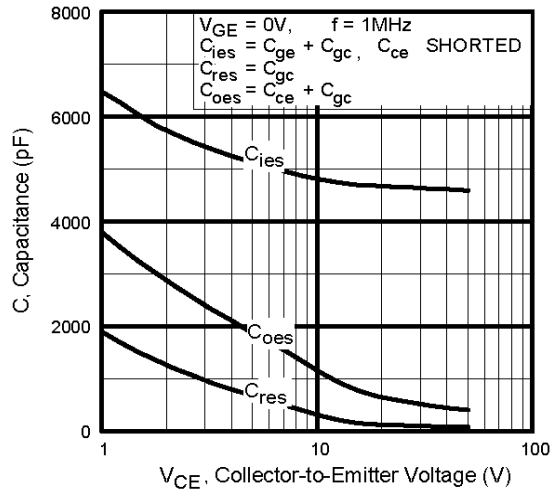

Fig. 7 - Typical Capacitance vs. Collector-to-Emitter Voltage

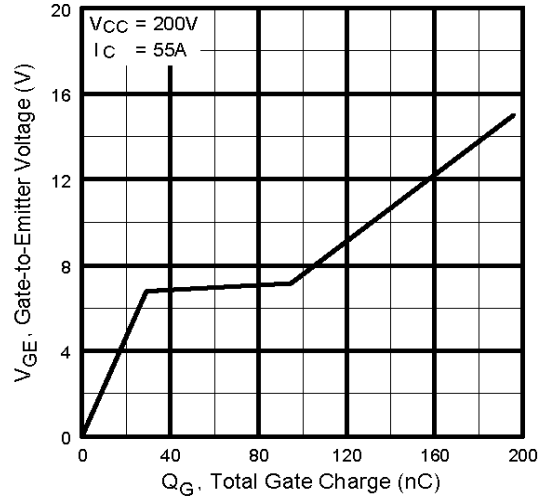

Fig. 8 - Typical Gate Charge vs. Gate-to-Emitter Voltage

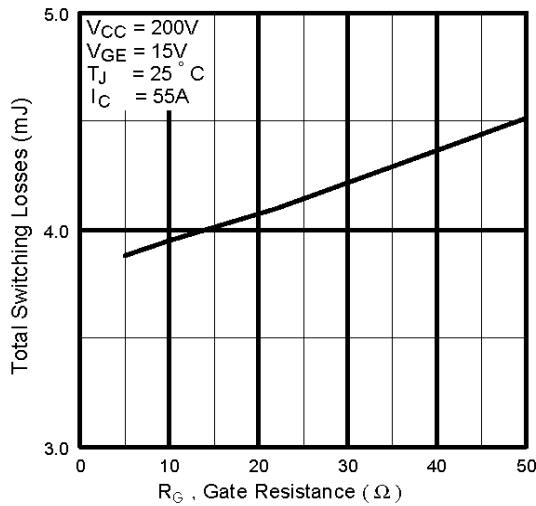

Fig. 9 - Typical Switching Losses vs. Gate Resistance

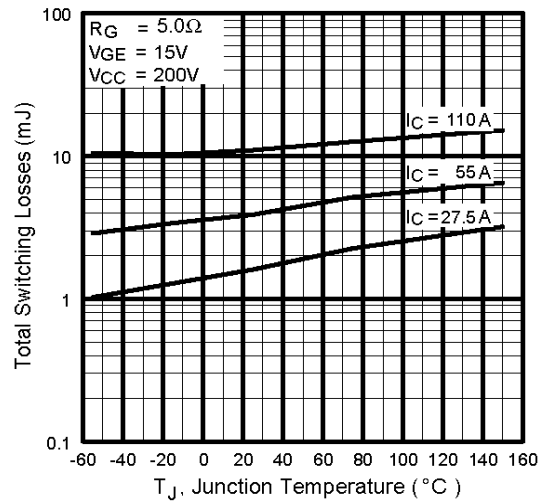

Fig. 10 - Typical Switching Losses vs. Junction Temperature

IRG4P254SPbF

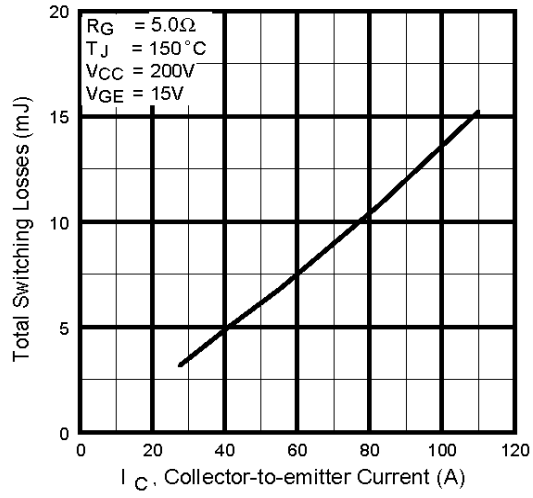

Fig. 11 - Typical Switching Losses vs. Collector-to-Emitter Current

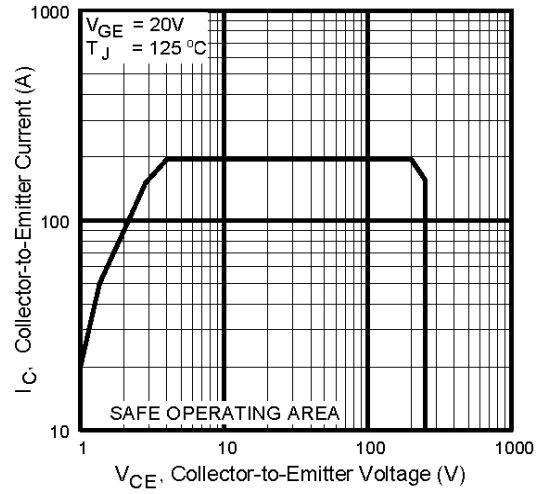
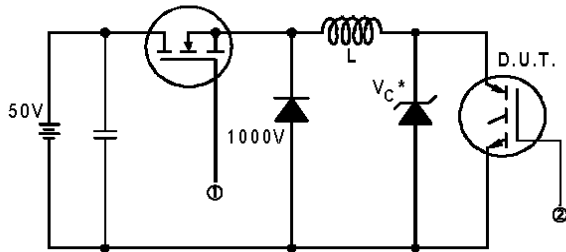

Fig. 12 - Turn-Off SOA



* Driver same type as D.U.T.; $V_C = 80\%$ of $V_{ce(max)}$
 * Note: Due to the 50V power supply, pulse width and inductor will increase to obtain rated I_d .

Fig. 13a - Clamped Inductive Load Test Circuit

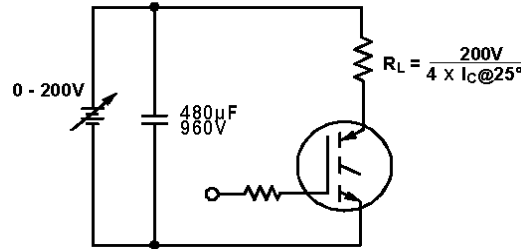

Fig. 13b - Pulsed Collector Current Test Circuit

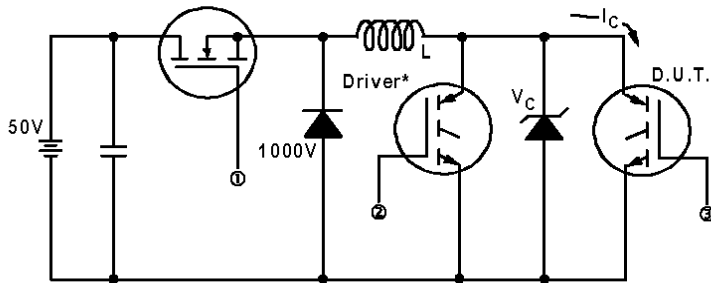

Fig. 14a - Switching Loss Test Circuit

* Driver same type as D.U.T., $V_C = 200V$

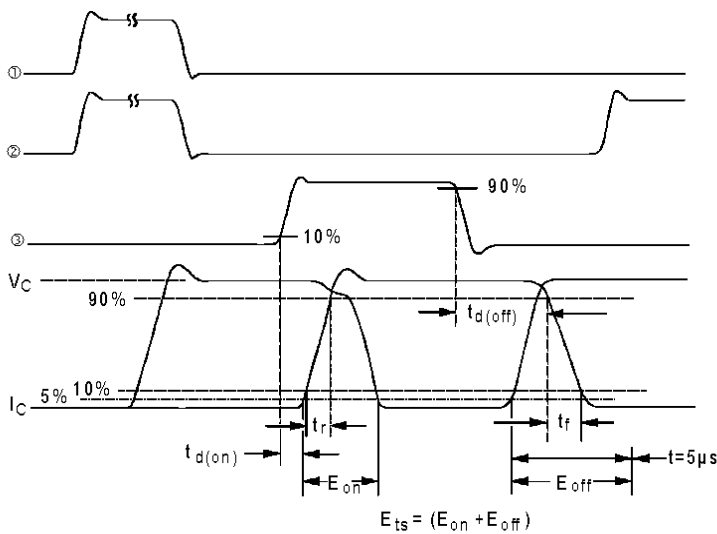

Fig. 14b - Switching Loss Waveforms

IRG4P254SPbF

International
IR Rectifier

TO-247AC Package Outline

Dimensions are shown in millimeters (inches)

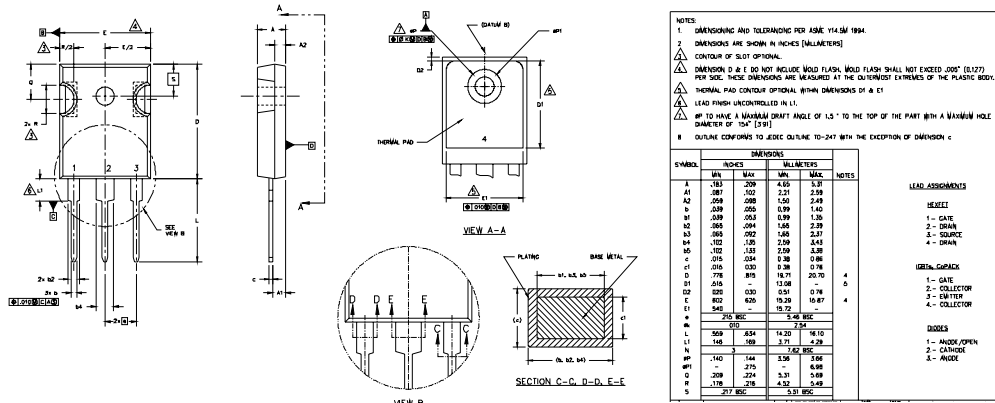

TO-247AC Part Marking Information

EXAMPLE: THIS IS AN IRFP30
WITH ASSEMBLY
LOT CODE 5657
ASSEMBLED ON WW 35, 2000
IN THE ASSEMBLY LINE "H"

Note: "P" in assembly line
position indicates "Lead-Free"

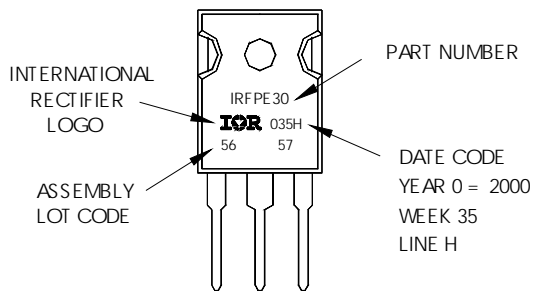

Data and specifications subject to change without notice.

International
IR Rectifier

IR WORLD HEADQUARTERS: 233 Kansas St., El Segundo, California 90245, USA Tel: (310) 252-7105

TAC Fax: (310) 252-7903

Visit us at www.irf.com for sales contact information. 07/04

www.irf.com

Note: For the most current drawings please refer to the IR website at:
<http://www.irf.com/package/>